



Versatile manual backpack sprayer with 12 and 16 litre capacity respectively, with stainless steel lance. Sprayer suitable for use in gardening and agriculture.



### Advantages

- Greater strength and performance to agrochemicals thanks to the robustness of the FPM seal and the stainless steel handle.
- Maintenance without tools.
- Possibility of mixing inside the tank thanks to the translucent liquid level indicator.
- Homogeneous treatment thanks to the pressure regulator.
- It includes a selection of nozzles that allows different types of application.
- Ambidextrous and lightweight keeping the ergonomics .
- Suitable for application of products of natural origin (pelargonic, acetic, etc...).



### Technical information

Technical information	EVOLUTION 12	EVOLUTION 16
HOSE	1,3 m (PVC)	
STANDARD NOZZLES	Adjustable conical	
LANCE	Fibreglass (71 cm)	
USABLE CAPACITY	12 L	16 L
TOTAL CAPACITY	13,3 L	17,7 L
LITRES/MIN. 1,5 BAR	0,56 l/min	
LITRES/MIN. 3 BAR	0,80 l/min	
NET WEIGHT	3,4 Kg	3,54 Kg
INTEGRATED SYSTEM TO RELEASE THE CYLINDER WITHOUT EMPTYING	YES	
WIDE FILLER OPENING	YES	
SET OF NOZZLES FOR HERBICIDE AND INSECTICIDE TREATMENTS	YES	
REINFORCED PRESSURE CHAMBER	YES	
TRANSLUCENT LEVEL INDICATOR	YES	
STANDARD ACCESSORIES	Pressure regulator, set of nozzles (herbicide elbow plus fan, mirror and disc nozzles), two seals (1 rubber and 1 synthetic) and a dispenser	
LANCE AND EXTENSIONS	Lance/Lever	
STRAPS	Adjustable and padded	
CHAMBER SEAL	FPM	
PRESSURE REGULATOR	YES (3 positions)	
HANDLE	Stainless steel	

### Logistics data

Logistics Data	EVOLUTION 12	EVOLUTION 16
CODE	8.49.59	8.49.51
EAN	84.14685.20111.9	84.14685.20097.6
CONDITIONING	1 unit	
UNITS PER PALLET	18 units	
DIMENSIONS PER PALLET	1200 X 800 X 1180	

### MAINTENANCE KITS



**PR MAINTENANCE KIT**  
Reference 8.39.41.871  
Keep your sprayer at peak performance. Designed for 12-20 L sprayers.

ROUND SEAL AN-8 No. 101	2.23.15.908
STAINLESS STEEL BALL Ø 12 NO. 119	2.20.08.902
VITON SEAL NO. 120	8.39.11.305
ROUND SEAL AN-5 NO. 136	2.23.15.905
CHAMBER VALVE NO. 365	8.39.41.303
FILTER WASHER NO. 1034	8.49.41.410



### Functional information



Stainless steel handle



Pressure regulator



Ergonomic and robust clamping nut



Lance/lever support



Integrated system to release the cylinder without emptying



Reinforced chamber with FPM retainer for intensive use



Integrated and comfortable transport handle

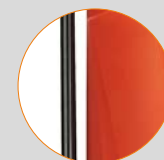

Stainless steel lance



Large filling opening

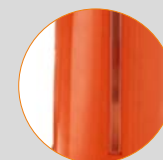

Translucent liquid level indicator

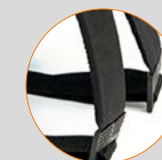

Adjustable padded straps



## ACCESSORIES

Personalize your sprayer adapting it to your application needs (height, hard-to-reach areas...)



**3.2 M TELESCOPIC LANCE**  
Reference 8.35.40.913  
**5.4 M TELESCOPIC LANCE**  
Reference 8.35.40.915



**4-HOLE NOZZLE**  
Reference 8.34.46.801



**CONICAL HOOD**  
Reference 8.34.60.981  
**RECTANGULAR HOOD**  
Reference 8.34.60.980



**DOUBLE ADJUSTABLE NOZZLE**  
Reference 8.34.46.802



**FLEXIBLE DOUBLE NOZZLE**  
Reference 8.35.40.871



**ANTI-DRIFT NOZZLE (INDUCED AIR) 80°**  
Reference 8.34.46.814  
**ANTI-DRIFT NOZZLE (INDUCED AIR) 120°**  
Reference 8.34.46.804



**LOW-VOLUME WEED-KILLERS ELBOW**  
Reference 8.34.60.935

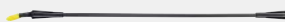

**1 M FIBREGLASS LANCE TUBE WITH COMPLETE ELBOW**  
Reference 8.34.60.873  
**1.5 M FIBREGLASS LANCE TUBE WITH COMPLETE ELBOW**  
Reference 8.34.60.874

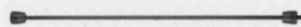

**EXTENSION 0.5M**  
Reference 8.35.40.870



**PRESSURE REGULATOR (EVOLUTION - AGRO GREEN TYPE)**  
Reference 8.35.47.870



**NOZZLE SET**  
Reference 8.34.46.815.1

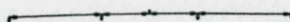

**QUADRUPLE BOOM**  
Reference 8.34.60.870



**EXTENDIBLE DOUBLE NOZZLE**  
Reference 8.35.40.872



**NORMAL WEED-KILLERS ELBOW**  
Reference 8.34.60.934

## SPARE PARTS

Extend the service life of your sprayer easily replacing parts

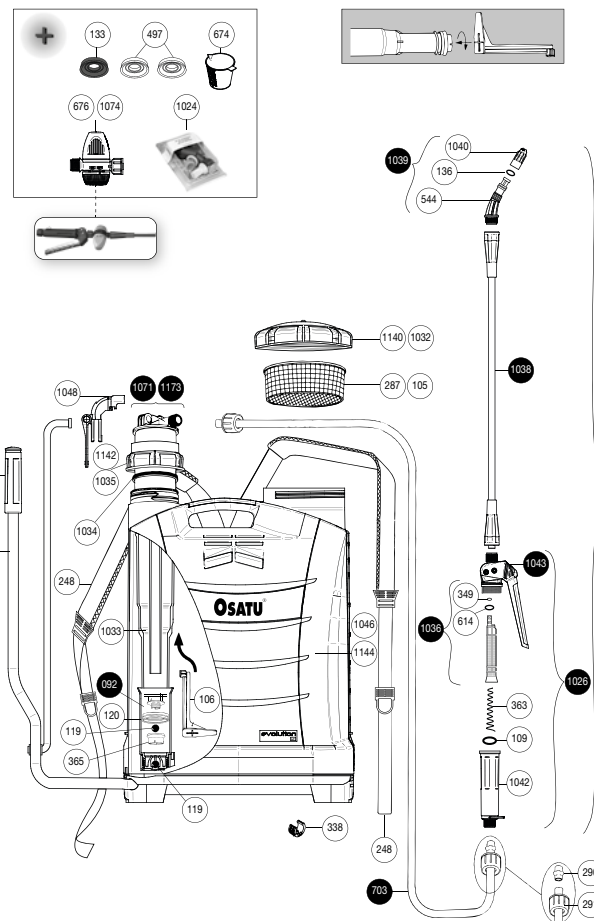

N.	COD.	Q	SPARE PARTS NAME
92	8.39.41.603	1	CYLINDER WITH BALL
105	8.39.18.303	1	FILTER 16 L. TANK
106	8.39.47.306	1	AGITATOR
109	2.23.15.916	1	ROUND GASKET AN-16
119	2.20.08.902	2	STAINLESS STEEL BALL Ø 12
120	8.39.11.305	1	VITON SEAL
133	8.39.09.306	1	RUBBER SEAL
136	2.23.15.905	1	ROUND GASKET AN-5
248	8.39.41.364	2	STRAP
287	8.39.06.303	1	FILTER 12 L. TANK
290	8.38.08.308	2	HOSE BUSHING
291	8.42.02.332	2	NUT
338	8.39.43.327	1	BASE BUSHING
349	2.23.16.903	1	ROUND GASKET AN-3
363	8.39.41.342	1	FILTER SPRING
365	8.39.41.303	1	SEALING VALVE
497	8.39.41.305	1	OPAQUE SYNTHETIC SEAL
544	8.28.40.322	1	SPRAYER
614	2.23.16.908	1	ROUND GASKET AN-8
674	8.39.41.350	1	100 ML DOSER
676	8.34.47.900	1	16 L. PRESSURE REGULATOR
703	8.39.18.805	1	COMPLETE HOSE
1024	8.34.46.815	1	NOZZLES SET
1026	8.49.41.801	1	COMPLETE HANDLE
1028	8.49.41.307	1	GRIP
1029	8.49.41.802	1	COMPLETE LEVER
1032	8.49.41.602	1	16 L. TANK COVER AND VALVE
1033	8.49.41.302	1	PRESSURE CHAMBER
1034	8.49.41.410	1	LOCKING WASHER
1035	8.49.41.304	1	16 L. GUIDE LID
1036	8.49.41.812	1	FILTER WITH GASKET
1037	8.49.41.823	1	COMPLETE LANCE
1038	8.49.41.627	1	TUBE WITH NUTS
1039	8.49.41.808	1	ELBOW WITH NOZZLE
1040	8.49.41.315	1	NOZZLE Ø 1,5
1042	8.49.41.367	1	GRIP
1043	8.49.41.604	1	12 L. HANDLE BODY
1046	8.49.51.850	1	16 L. TANK
1048	8.49.51.811	1	LANCE HOOK
1071	8.49.48.814	1	16 L. COMPLETE CHAMBER
1074	8.34.47.800.3	1	12 L. PRESSURE REGULATOR
1140	8.49.49.602	1	12 L. TANK COVER AND VALVE
1142	8.49.49.304	1	12 L. GUIDE LID
1144	8.49.59.850	1	12 L. TANK
1173	8.49.49.814.1	1	12 L. COMPLETE CHAMBER
	8.49.51.200	1	16 L. INSTRUCTION SHEET
	8.49.51.201	1	16 L. PACKAGING
	8.49.59.200	1	12 L. INSTRUCTION SHEET
	8.49.59.201	1	12 L. PACKAGING